

Neon Track TLS-R

Specification

TLS-R35S



TLS-R series, the newest Neon Track designed by Colors.

It adopts modernist design style, fashionable appearance and extreme simplicity.

Modular function, diversified light distribution, convenient installation.



φ35mm spotlight

The Neon Track system can realize hoisting and surface installation; the track can be equipped with neon strip / tube, and the system provides linear lighting modules such as Diffuser, Prismatic, Grating, Asymmetric, spotlight and pendant light modules. Modules can be freely combined and can be applied to different scenes; the track adopts 48VDC power supply.



specifications:

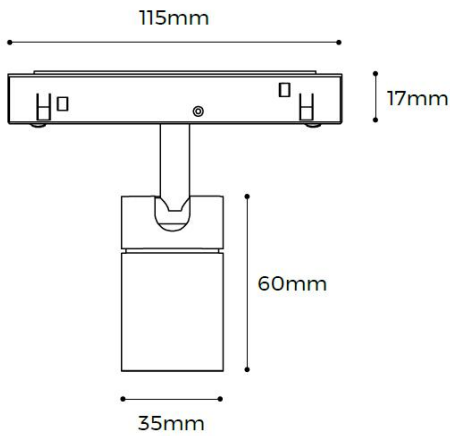

TLS-R35S (6W)

Optical & electronic data:

Input voltage	48VDC	LED Brand	Bridgelux
Power	6W	MacAdam	SDCM< 5 step
Lumens	550LM	IP Code	IP20
CCT	3000K/4000K	IK Class	IK00
CRI	90	Adjustable	NO
Beam angles	16°、24°、34°	Working temp	-20°C-30°C
Efficiency	92LPW	Installation	Magenetic Track
Color	Black	IES File	Yes
Dimmable	No Dimming	Lifetime(TM-21)	50000h@ Ta=25°C (L80/B10)
Certificates	CE/RoHS	Warranty	5 years

Remark:

- 1、 the output data is based on the testing result of 4000k luminaires;
- 2、 the tolerance of output data can be vary up to 10%;
- 3、 the output data is typical value;



AAI Figure

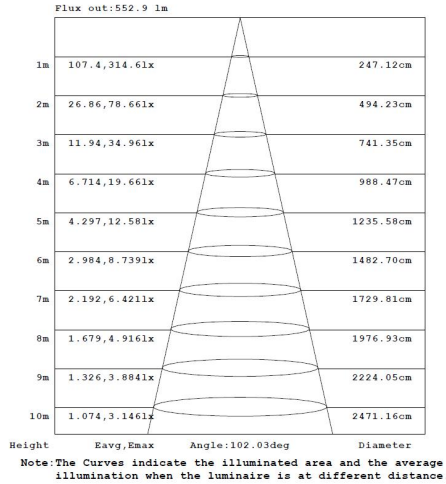

Luminous intensity distribution diagram

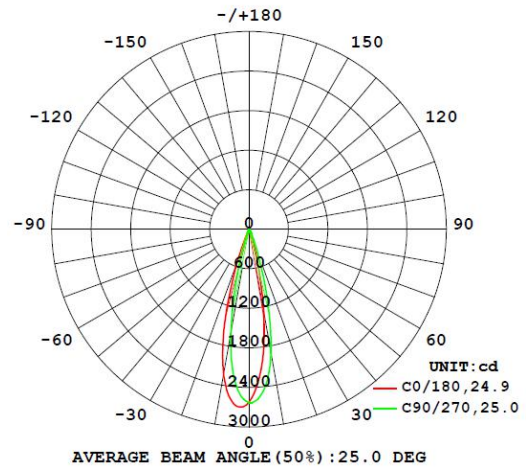

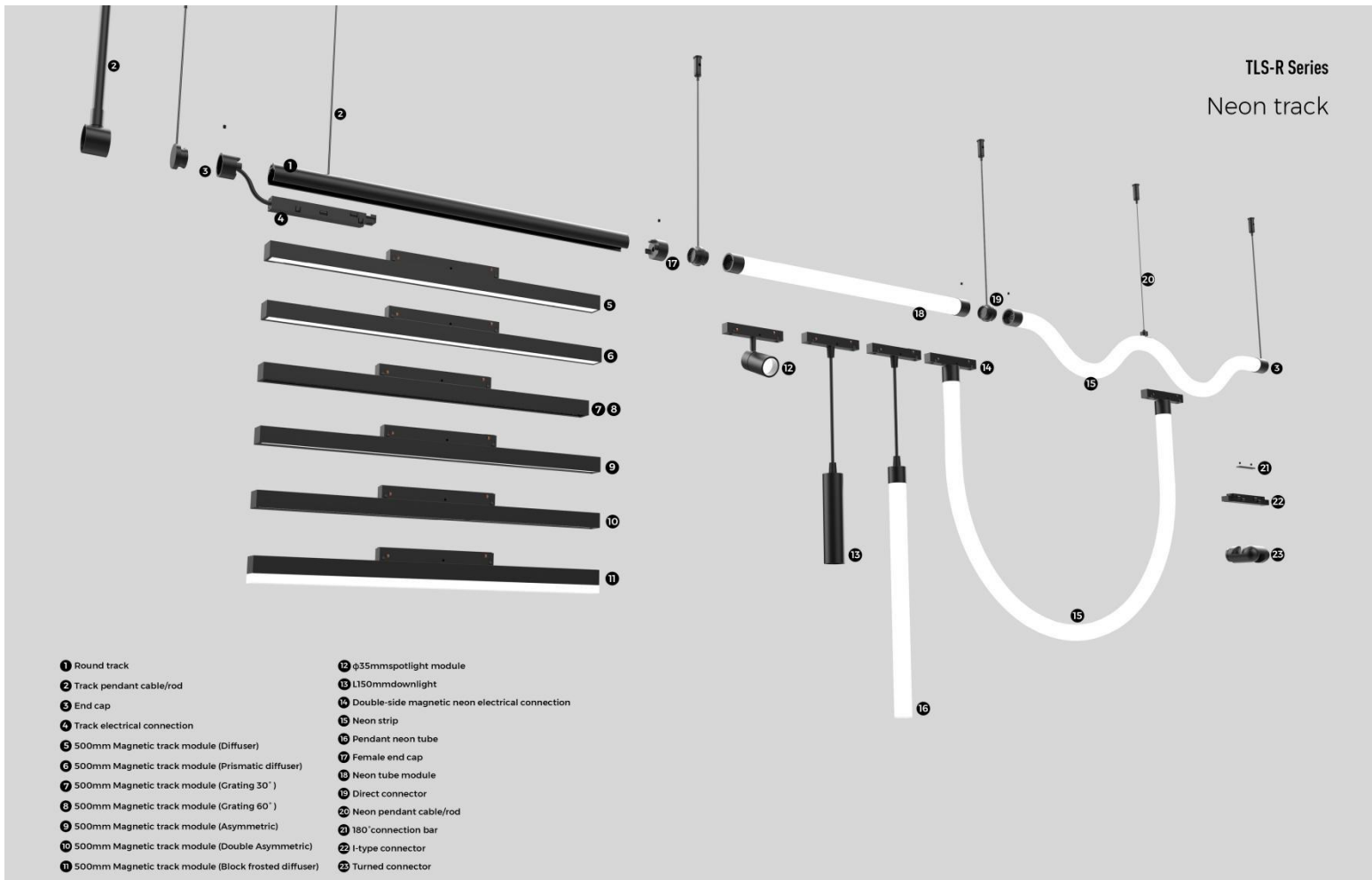

Product system solution diagram:











Accessories information :

*Please refer to the above figure "Product system solution diagram", the corresponding accessory serial number to order

Model	Describe	Picture	Order model	NW KG/PCS	NO.
Round track	Round magnet track: 1m、2m、3m		TLS-R610-B TLS-R620-B TLS-R630-B	800g 1600g 2400g	1
Track pendant cable	It is used for pendant of track cable		PN-SA2	80g	2
Track pendant rod	It is used for pendant of track rod		TLS-R891-B	350g	
End cap	When the track and neon module are powered on, the Sewing device plays the role of fixing on the ceiling and adjusting the length of the Pendant cable.		TLS-R600A-B	65g	3
Endcap (Without Sewing device)	When used for Suspender installation, there is no need Sewing device		TLS-R600B-B	25g	
End cap (Without Sewing device and Pendant cable)	Use this when no Sewing device or Pendant cable is required		TLS-R600C-B	15g	
Power feeder unit of track	It is used for track power supply and needs to be used with 1pcs End cap		TLS-R862-B	51g	4
Double-side magnetic neon electrical connection	With neon Neon strip, It can be a neon double head magnetic suction module		TLS-R864-B	45g	14
Female end cap	Only the Female end cap is included. It can be used when there is no need for Power feeder unit of track		TLS-R865-B	20g	17
Straight connector	It can realize direct connection between track and neon module, the Sewing device plays the role of fixing on the		TLS-R861A-B	71g	19



	ceiling and adjusting the length of the Pendant cable.				
Straight connector (Without Sewing device)	When used for Suspender installation, there is no need Sewing device		TLS-R861B-B	31g	
Straight connector (Without Sewing device and Pendant cable)	Use this when no Sewing device or Pendant cable is required		TLS-R861C-B	21g	
Pendant cable (Neon)	Used for neon Pendant of cable		TLS-R892-S	120g	20
Pendant rod (Neon)	Used for neon Pendant of rod		TLS-R893-B	350g	
180°extender	It is used to fix the back structure in track splicing		EX-E1-S	15g	21
I-type electrical connector	It is used to power on when the track is spliced		TLS-R863-B	30g	22
Turned connector	It can realize the corner connection of the track and neon module, and the horizontal rotation is $\pm 120^\circ$ and the Sewing device can fix on the ceiling and adjust the length of the Pendant cable		TLS-R860A-B	162g	23
Turned connector (Without Sewing device)	When used for Suspender installation, there is no need Sewing device		TLS-R860B-B	122g	
Turned connector (Without Sewing device and Pendant cable)	Use this when no Sewing device or Pendant cable is required		TLS-R860C-B	112g	



Packing:

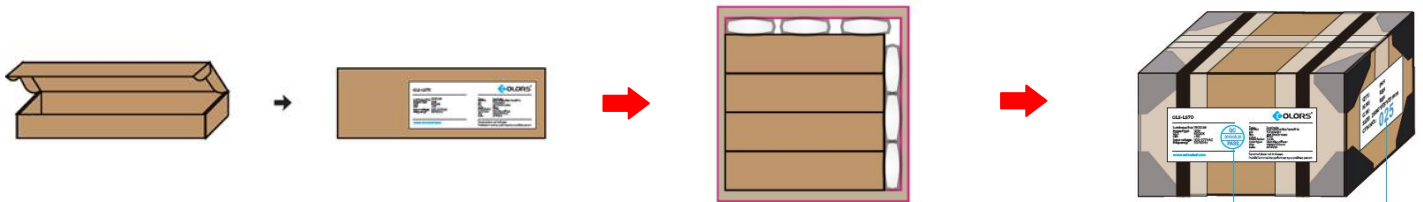

Model	Type	Demension (individual package)	Pcs /box	NW (Kg)	GW (Kg)	Demension (whole package)	CBM (m ³)
TLS-R35S	Folding box	510*57*28mm	6	0.72	0.9	550*255*260mm	0.04

Ordering code:

Category	Series	Section Size	Diffuser shape	Diffuser Nature	Carrier Style	Profile Color	End Cap Style	Length	Light Source Type	Type Power of Luminaire	CCT	CRI	Power Type	Package	Label Type
TLS	Low Voltage Magnetic round track Installation	R 35 Series 35	Spotlight S	16° E	No Carrier X	Black B	Holeless end cap S	35WA	Constant Current Rigid T	6W 6	3000K WW	>90 9	No Power X	Distribution Individual D	COLORS C
				24° F							4000K NW				Customized S
				34° G											
TLS	-	R	35	S	F	X	B	S 35WA	-	T	6	NW	9	X	D C

TLS-R35SFBS35WA-T6NW9X-DC

