

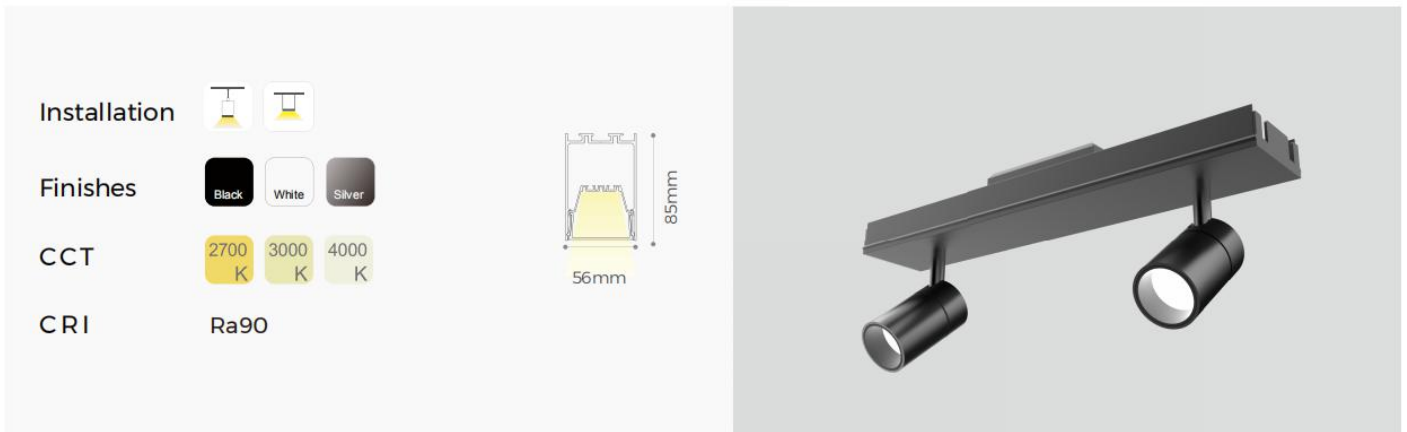

Specification

M60SF-35WB - Double Soptlight







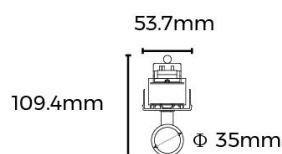
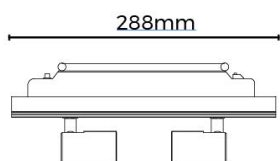







- AL6063-T5 aluminum profile with high-quality surface treatment process, multiple colors optional, such as black, white, silver etc.
- High light efficacy design, up to 125 lm/W.
- Five standard corner styles options (L-type, X-type, T-type), realize free splicing in three-dimensional and plane.
- Multiple optical styles optional(diffuser, microprism, grating 12°/24°/38°, asymmetric, double asymmetric, soptlight, downlight etc.), meet the needs of multiple applications.
- Support 0-10V & bluetooth dimming control

Modular specification:



Optical & electronic data:

												
	Diffuser	Microprism	Louven	Grating 12°	Grating 24°	Grating 38°	Asymmetric	Double asymmetric	Single spotlight	Double spotlights	Double recessed spotlights	Blind diffuser
300mm	/	/	/	11W/1050LM	11W/1100LM	11W/1000LM	/	/	12W/1050LM	12W/1100LM	6W/400LM	/
600mm	19W/2000LM	19W/1700LM	19W/1350LM	15W/1400LM	15W/1500LM	15W/1350LM	/	/	/	/	/	/
1200mm	37W/3880LM	37W/3300LM	37W/2600LM	/	/	/	27W/3100LM	27W/3500LM	/	/	/	/
2400mm	68W/7150LM	68W/6120LM	/	/	/	/	/	/	/	/	/	/
2500mm	/	/	/	/	/	/	/	/	/	/	/	✓







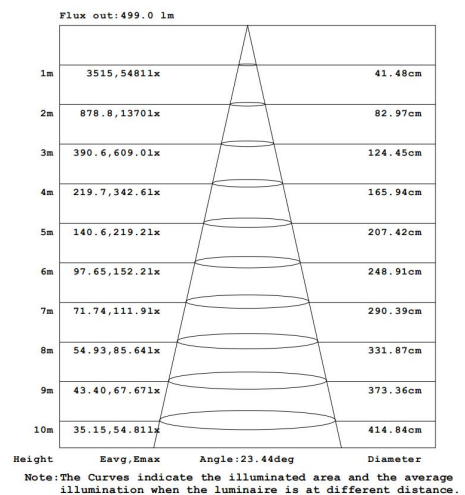
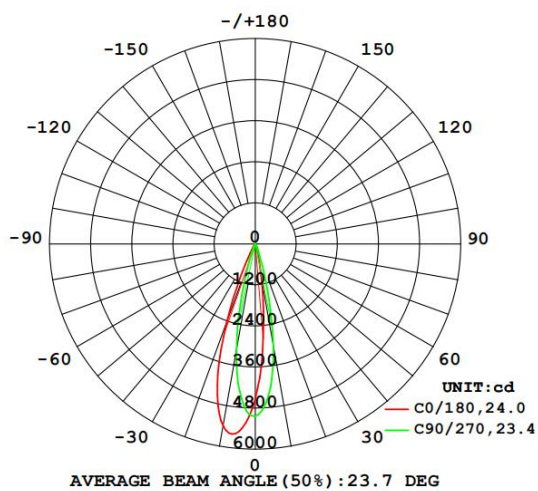







Remark :

- 1、 The above data are based on CRI 80 , 4000K standard lamp test ;
- 2、 the tolerance of output data can be vary up to 10% ;
- 3、 the output data is typical value ;

The test data for 1.2M lamp:



Accessories

Picture	Name	Code	Description
	Profile	PR-LS60B2500	Size : L2500*W56*H85mm Material : AL6063-T5 Surface processing : (Silver, White RAL9003, Black RLA9005)
	Blind diffuser	CV-LS60FB2500-B	Size : L2500*W53.7*H22.8mm Material : AL6063-T5 Surface processing : (Silver, White RAL9003, Black RLA9005)
	End caps (Profile)	EC-LS60FBS	Size : L85*W56*H10mm Material : AL6063-T5 Surface processing : (Silver, White RAL9003, Black RLA9005)
	End caps (Blind diffuser)	EC-M60FBS	Size : L53.7*W18.8*H8.2mm Material : AL6063-T5 Surface processing : (Silver, White RAL9003, Black RLA9005)
	Pendant cable	PN-LA2/LA4	
	Surface mounted buckle	CL-06	
	Pendant installation clip	CP-16	
	No Dimming line (One meters)	CM-07	Module connecting wire, 1m, 3PIN, non-dimmable
	No Dimming line (Two meters)	CM-08	Module connecting wire, 2m, 3PIN, non-dimmable
	Dimming line (One meters)	CM-09	Module connecting wire, 1m, 5PIN, dimmable
	Dimming line (Two meters)	CM-10	Module connecting wire, 2m, 5PIN, dimmable
	Connector	EX-34	Size : L200*W51.4*H25mm
	L shaped corner	L90-LS60FBXB	Size : 200*200*85mm , without lighting source
	L shaped corner (light from inward)	L90N-LS60FBXB	Size : 200*200*85mm , without lighting source
	L shaped corner (light from outward)	L90W-LS60FBXB	Size : 200*200*85mm , without lighting source

	X shaped corner	X90-LS60FBXB	Size : 305*188*85mm , without lighting source
	T shaped corner	T90-LS60FBXB	Size : 350*350*85mm , without lighting source

Description about label information :

M60SF-35WB



Luminous flux: 1100LM

Power(Typ): 12W

CCT: 4000K

CRI: >90

Input voltage: 200-220VAC

Type: Luminaire

Part NO: LLS-M60SFXBS35WB-T12NW9D-DC

SO:

NO:

Color: Black

Power factor: >0.95

Cover type: Double soptlights

Size:

Date:

www.colorsled.com

Terminal block not included.
Installation must be performed by a qualified person.

Ordering code :

Category	Series	Section Size	Diffuser Shape	Diffuser Nature	Carrier Style	Profile Color	End Cap Style	Length	Light Source Type	Light Source Power	CCT	CRI	Power Type	Package	Label Type	
Stylish Lighting system	LLS - Modular M	60	Flat F	Diffuser D	NO X	Silver S	Holeless end cap S	35RB - 35RB	Constant Currentstrip	T	12W 12	2700K SW	>90 9	0-10V Dimming B	COLORS Individual D	COLORS C
			Lens G	Microprism P		White W	3000K WW									Customized S
			Grating L	12° E		Black B	4000K NW									Bluetooth Dimming G
			Louven B	24° F												
			Soptlight S	38° G												
	Transparent T															

Ordering luminaires kits

LLS-M60SFXBS35WB-T12NW9B-DC



Attentions :

- Please install the product in the right environment as much as possible ;
- Please be careful during operation. Do not touch the AC power supply in case of electric shock ;
- Check the current through the circuit, such as the surge occurs when press the switch does not exceed the maximum rated current, please insert the appropriate protection circuit ;
- This product is sensitive to static electricity, and please special attention. In particular, it will damage the product when the static electricity is more than absolute maximum rated current and voltage, please make a countermeasures to avoid the damage of the static electricity and surge when using the product.



Huacai (Shenzhen) Opto-Electronics Co.,Ltd

Building A5, Qixing Wisdom Park,Shiyan
Youth Road, Bao'an District, Shenzhen, China
E-mail: colors@colorsled.com
Tel: +86-755-2923 1888
www.colorsled.com