

Specification

Linear lighting system

LS7977



LS7977



Features



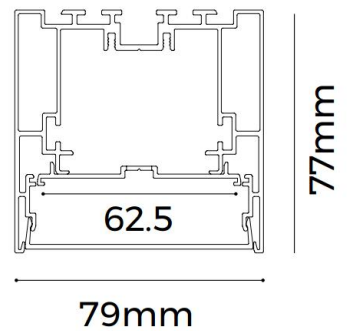

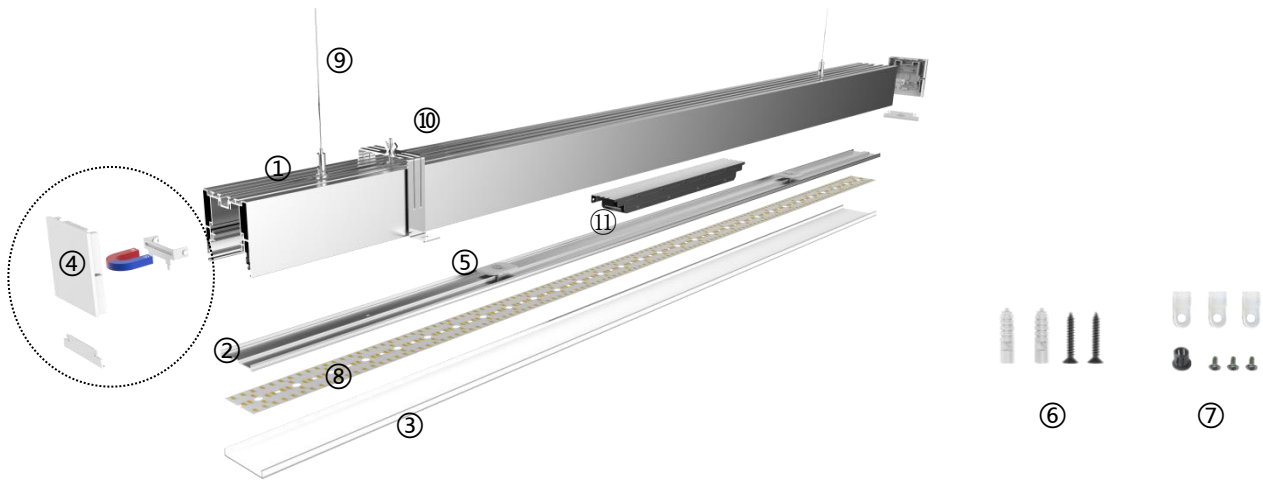

- Creative magnetic end cap, connect in seconds
- Designed in creative carrier buckle extremely convenient for installation and maintenance
- Designed in anti-leaky block piece , perfect details
- PC diffuser imported form Germany , producing homogeneous & soft lighting
- Provide standard extenders , customizable interconnected corners
- Built-in linear power supply , invisible and beautiful
- Various installation ways: pendant, recessed, surface and wall mounted



Details











Standard Configuration









Picture	Item	Parameter
	①Profile ②Carrier:	Profile weight : 2.25kg/2.5m Size : L2500*W79*H77mm Material : AL6063-T5 Surface processing : Anodizing
	③Cover	Type: Frosted diffuser Material : PC Light transmittance : 86% Size : L2500*W72.3*H10mm PC Feature : The diffuser will extend (shrink) 0.8mm/m when the temperature raises (drops) 10°C.
	④End cap	Model : EC-LS7977FSS Size : L79*W77*H11.5mm
	⑤Quick locker	Model : BK-03 Size : L48.5*W22*H9mm
	⑥Screw set	Model : CL-01 Size : M3.5*40mm
	⑦Cable clip	Model : BG-02



Optional Accessories

Picture	Item	Parameter
	⑤Flexible strip D8420-24V-59mm	Material : FPC,CCT:1900/2300/2700/3000/3500/4000/5000/6000K ; CRI > 80/>95 ; Voltage : 24V ; Power : 30W/m ; Lumen : 3900Lm/m ; Width : 59mm ; Minimum cutting unit : 21LEDs/50mm ;
	⑤Rigid modular DY8420-24V-62mm	Material : FR4,CCT:1900/2300/2700/3000/3500/4000/5000/6000K ; CRI > 80/>95 ; Voltage : 24V ; Power : 30W/m ; Lumen : 3900Lm/m ; Width : 62mm ; Minimum cutting unit : 21LEDs/50mm ;
	Pendant cable with junction box	Model : PY-LXXX Junction box L80*W80*H30mm
	Pendant cable without junction box	Model : PN-LXX Steel cable D1.5*2000/4000mm
	Recessed buckle	Model : RE-04 Size : L135.4*W25*H90mm
	Surface mounted buckle	Model : CL-09 Size : L126*W54*H5.9mm
	Reflective paper	Model : BG-13 Size : L15000*W16*H0.075mm
	⑧Power supply	Model : BSD-V24-100S Size : L373*W39*H27mm

Corner fittings

EX-23	EX-E6 (7-type 120°)	EX-E7 (7-type 60°)	EX-E8 (L-type 120°)
			
EX-E9 (Y-type 120°)	EX-E10 (L-type 60°)	EX-E11 (X-type 60°+120°)	EX-E12 (T-type 60°+120°)
			



Corners

L-type corner (L90-LS7977)



Al6063-T5&PC
6.6W
L150*W150*H77mm

L-type inner corner(L90N- LS7977)



Al6063-T5&PC
6W
L150*W150*H79mm

L-type exterior corner(L90W- LS7977)



Al6063-T5&PC
8.6W
L150*W150*H79mm

T-type corner(T90- LS7977)



Al6063-T5&PC
7.6W
L200*W150*H77mm

X-type corner(X90- LS7977)

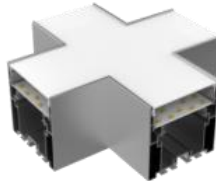

Al6063-T5&PC
10.1W
L200*W200*H77mm

180° extender



SPCC
silver
L80*W10*H2mm

* The corners can be provided with or without light source.

Optical Parameter

D8420-24V-59mm light source, frosted diffuser

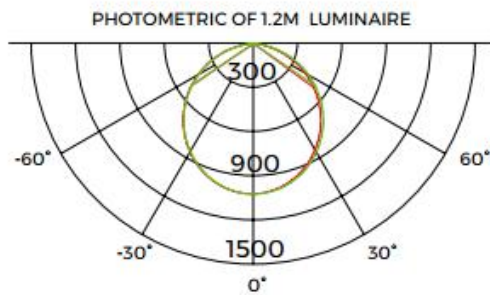

1m	298.6,1018lx	285.79cm
2m	74.65,254.5lx	571.57cm
3m	33.18,113.11lx	857.36cm
5m	11.94,40.7lx	1428.94cm
7m	6.094,20.77lx	2000.51cm
Height	Eavg,Emax	Angle:110.03deg Diameter



Package

Mode 1 :

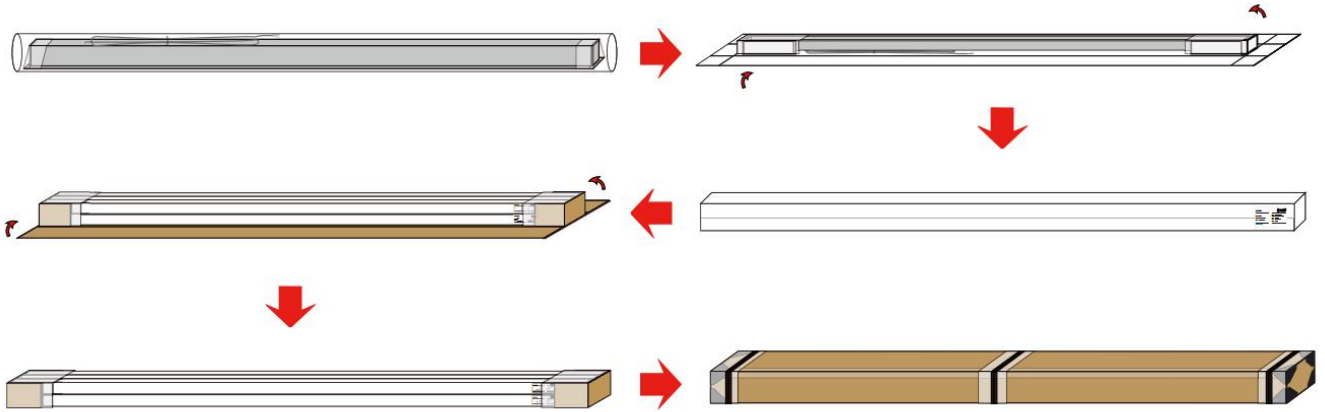

Mode 2 :

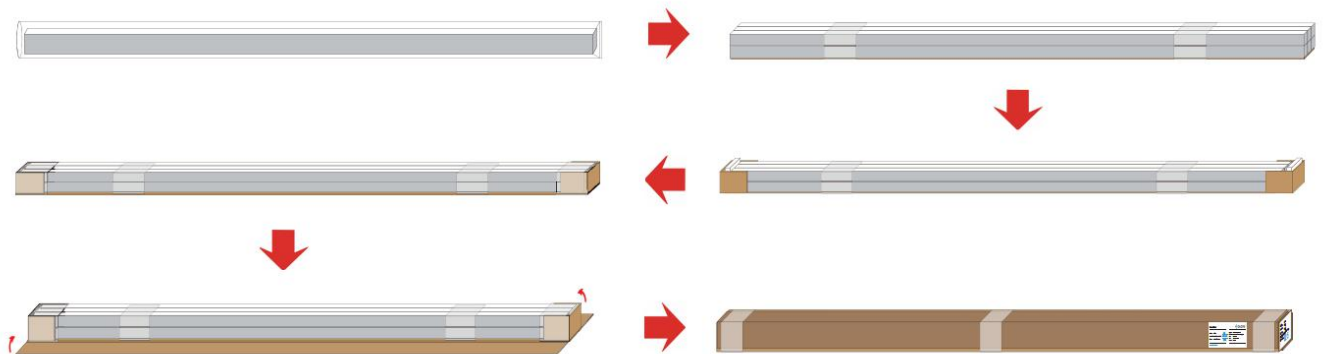

Components	Packaging material	Size(mm)	NW(kg)	GW(kg)	Content
Single piece	Hat box	2560*106*90mm	4.62	5.37	1pcs/box
Whole bundle	Hat box	2580*242*204mm	18.48	21.48	4pcs/box
Whole box packaging	Paper box	2580*188*182mm	18.48	21.48	4pcs/box

