

# Specification

Integrated Furniture Lighting

LS1612L



## LS1612L

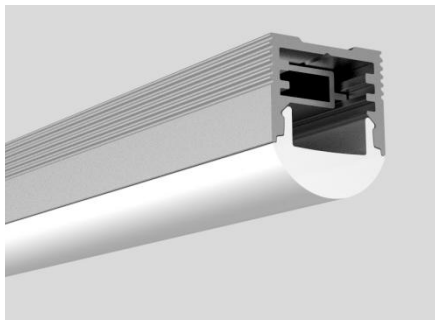

### Features

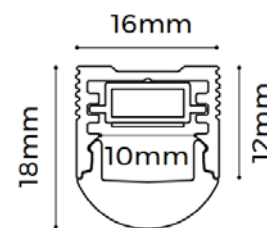

- By changing the position of the carrier, a variety of beam angles of 20° / 40° / 60° / 80° can be achieved
- AL6063-T5 aluminum profiles with high quality surface treatment and three optional colors of black, white and silver
- Close-fitting design without screws, optional end caps with or without holes

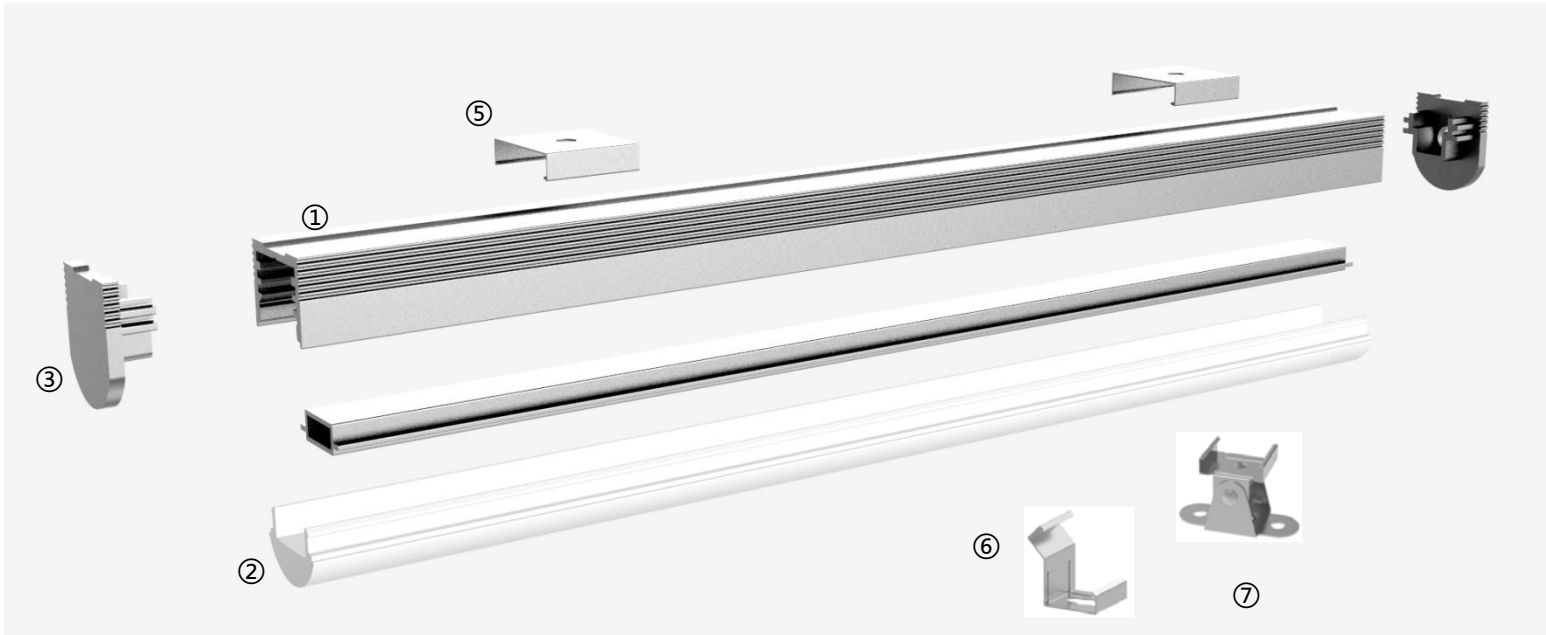

## Details









## Standard Configuration

Picture	Item	Parameter
	① Profile&Carrier	Material: AL6063-T5 Profile weight: 0.5kg/2.5m Size: L2500*W16*H12mm Surface processing: Anodizing
	② Cover	Type: Frosted diffuse Material: PMMA Light transmittance: 85% Size: L2500*W15.81*H9.94mm (shrink) 0.8mm/m when the temperature rises (drops) 10°C.
	③ End caps	Size: L16*W7*H18mm



## Optional Accessories

Picture	Item	Parameter
	FPC strip D6140-24V-8mm	Material: FPC, CCT: 2700/3000/4000/6000K; Ra > 90; Voltage:24V; Power: 6.6W/m; Lumen: 710Lm/m; PCB width: 8mm; Minimum cut: 50mm;;
	⑤Recessed clips	Size: L17.8*W15*H4.5mm
	③End cap with hole	Size: L16*W7*H18mm
	⑥45° installation clip	Size: L15.6*W12*H16.1mm
	⑦0-180° adjustable installation clip	Size: L35*W17.7*H21.4mm
	0-90°adjustable mounting clip	Size: L20*W20*H9mm



## Optical Parameter

D6140-24V-8mm ( light source, Clear sanding diffuser )

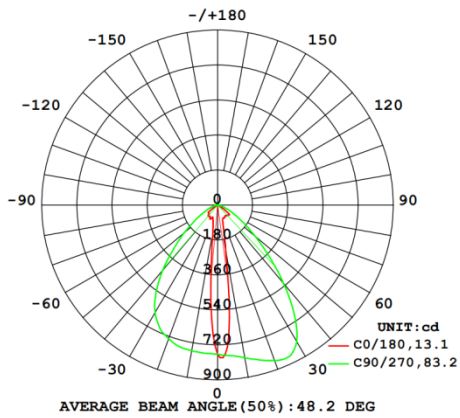

Beam angle: 20°

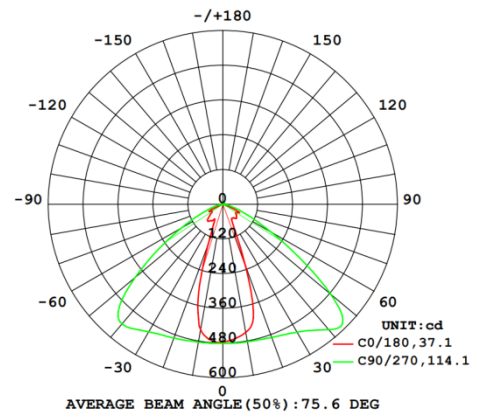
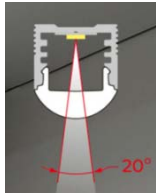

Beam angle: 40°

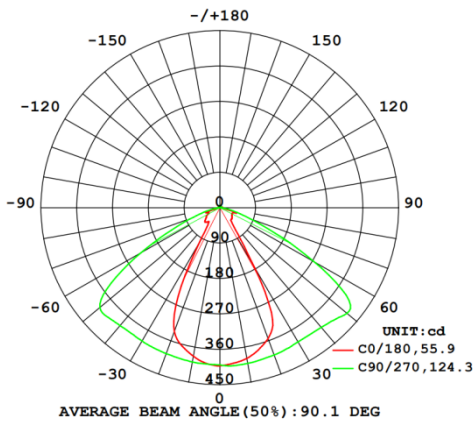
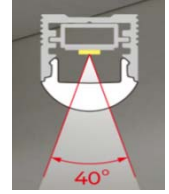

Beam angle: 60°

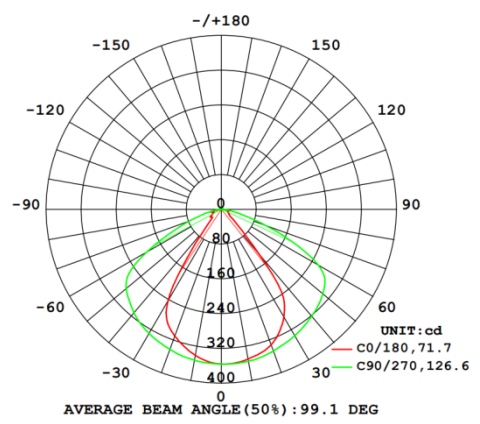
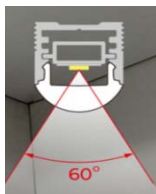

Beam angle: 80°

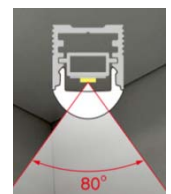

## Package

Mode 1 :

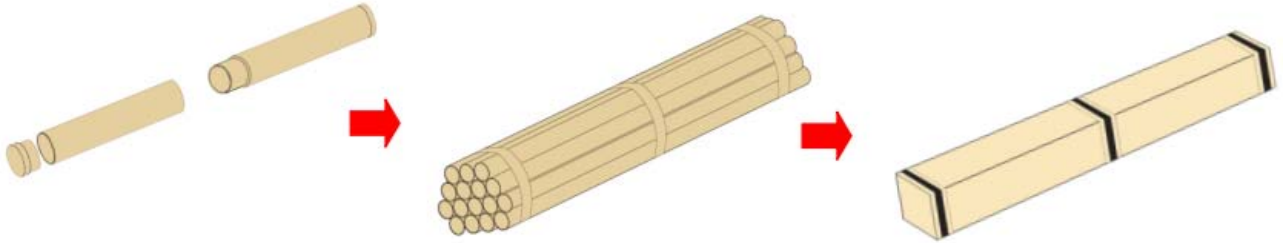

Mode 2 :

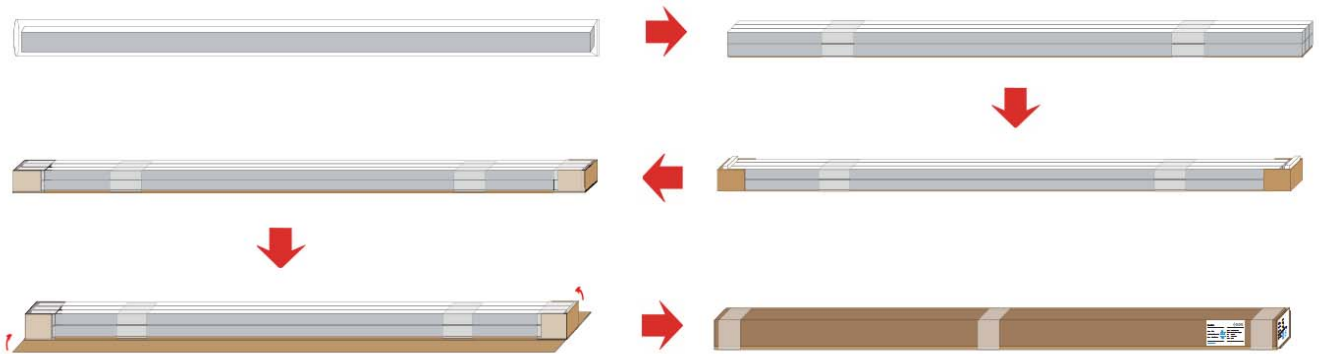

Components	Packaging material	Size(mm)	NW(kg)	GW(kg)	Content
Single piece	Hat box	Φ31mm*2580mm	0.76	1.21	1pcs/box
Whole bundle	Hat box	2580*250*165mm	25.08	41.93	33pcs/box
Whole box packaging	Paper box	2580*95*100mm	9.12	12.12	12pcs/box

