

# Specification

Integrated Furniture Lighting

LS1607



# LS1607

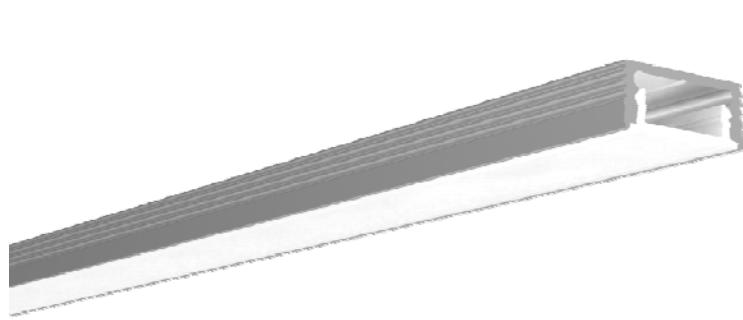

Example of application: furniture board  
Cutout:W17\*D8mm fixed by glass cement



## Features

DLS1.0, a special local auxiliary lighting system, can be widely used in various interior decoration scenarios and local light spaces. A touch of auxiliary decorative lighting in addition to the basic lighting creates different atmospheres and visual enjoyment.

Embellish life with light that follows you whenever you go.



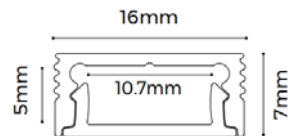

- 1、 “Dots-free”lighting  
Perfect homogenous lighting.
- 2、 Various diffuser options  
Several options of diffusers, In various shapes and light distribution plans Complete with everything needed
- 3、 “Two” end caps  
Two options of end cap for two ways of wire outgoing, Close-fitting design without screws makes installation much easier
- 4、 Various installation methods  
A wide range of installation accessories wider applications
- 5、 “One” cut.  
Consistent length between diffuser and profile
- 6、 Smart control for unlimited possibilities  
Perfectly match the profiles like customized, Control by hand sweep or touching

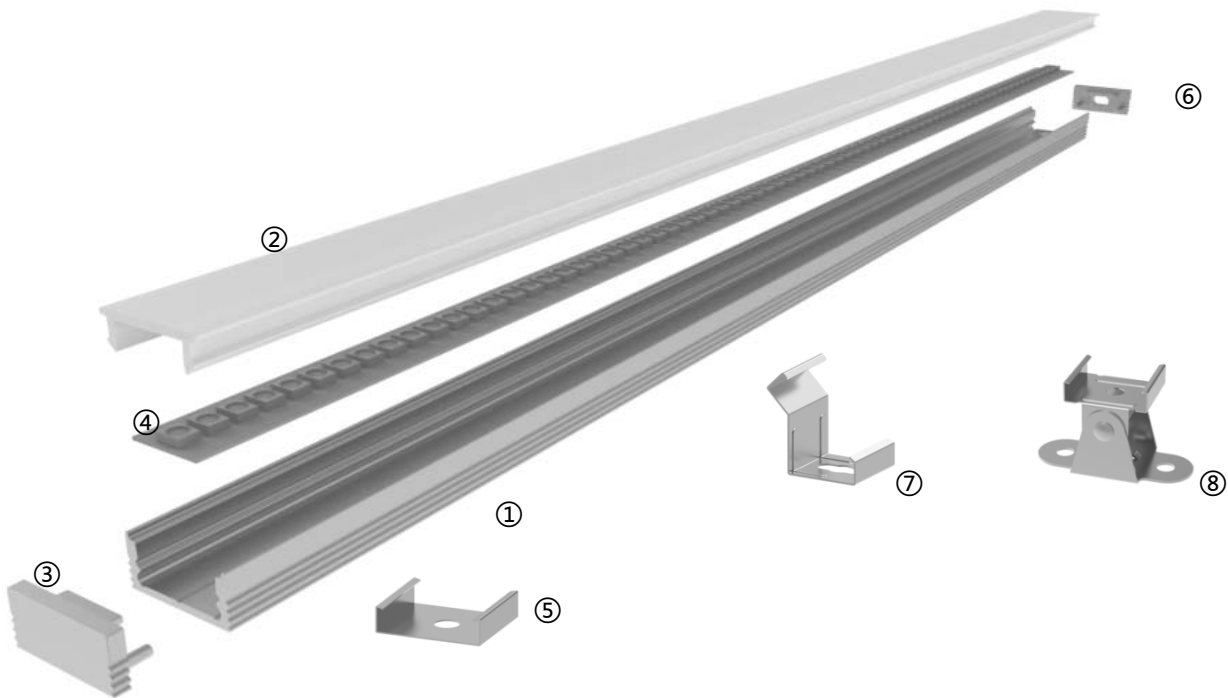

## Details

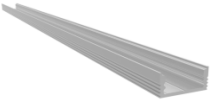



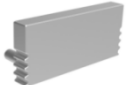



## Standard Configuration

Picture	Item	Parameter
	①Profile	Material: AL6063-T5 Profile weight: 0.22kg/2.5m Size: L2500*W16*H7mm Surface processing: Anodizing
	②Cover	Type: Frosted diffuse Material: PC Light transmittance: 60% Size: L2500*W14.7*H4.5mm (shrink) 0.8mm/m when the temperature rises (drops) 10°C.
	②Microprism diffuser	Type: Microprism diffuser Material: PC Light transmittance: 65% Size: L2500*W14.7*H4.5mm (shrink) 0.8mm/m when the temperature rises (drops) 10°C.
	②Black Microprism	Type: Black Microprism Material: PC Light transmittance: 15% Size: L2500*W14.7*H4.5mm (shrink) 0.8mm/m when the temperature rises (drops) 10°C.
	③End caps	Size: L16*W7*H6mm



## Optional Accessories

Picture	Item	Parameter
	④FPC strip D6280-24V-8mm	Material: FPC, CCT: 2700/3000/4000/6000K; Ra > 90; Voltage:24V; Power: 15W/m; Lumen: 1650Lm/m; PCB width: 8mm; Minimum cut: 25mm;
	⑤Recessed clips	Size: L17.8*W15*H4.5mm
	⑥End cap with hole	Size: L16*W7*H6mm
	⑦45° installation clip	Size: L15.6*W12*H16.1mm
	⑧0-180° adjustable installation clip	Size: L35*W17.7*H21.4mm
	0-90°adjustable mounting clip	Size: L20*W20*H9mm

## Optical Parameter

The testing result of 1M luminaire (with " D6280-24V-8mm " and diffuser)

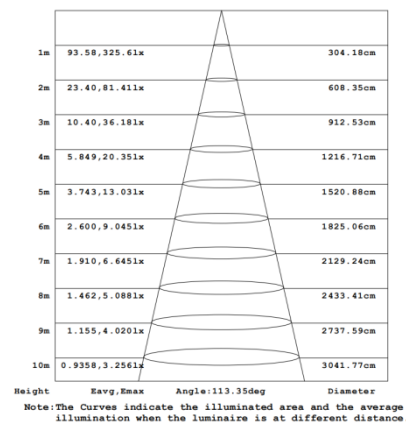
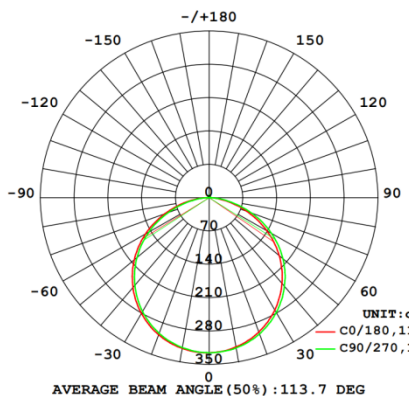

## Package

Mode 1 :

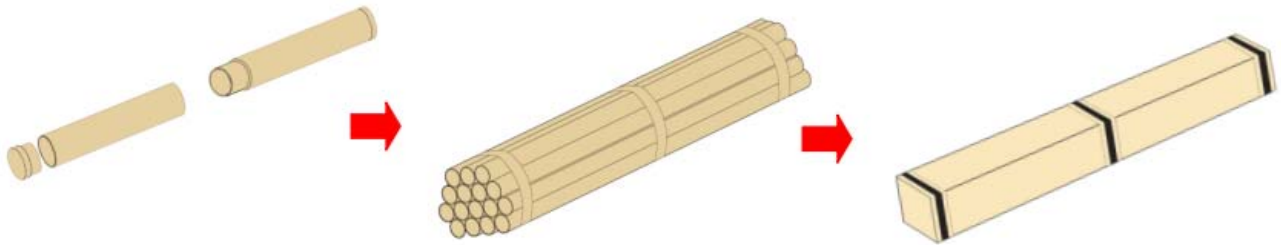

Mode 2 :

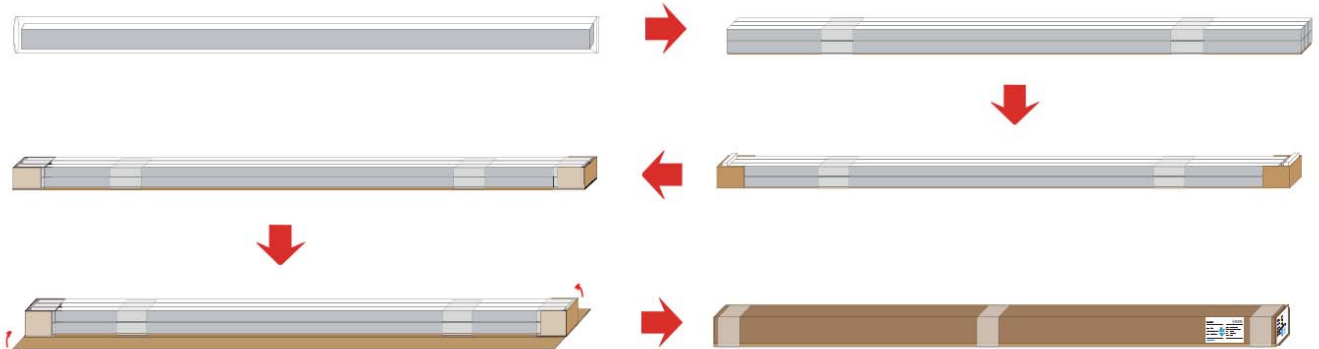

Components	Packaging material	Size(mm)	NW(kg)	GW(kg)	Content
Single piece	Hat box	Φ31mm*2580mm	0.4	0.99	1pcs/box
Whole bundle	Hat box	2580*250*165mm	13.2	34.67	33pcs/box
Whole box packaging	Paper box	2580*95*100mm	16	19	40pcs/box

