

# Specification

Architecture lighting integration series

LR3840(B)



## LR3840(B)

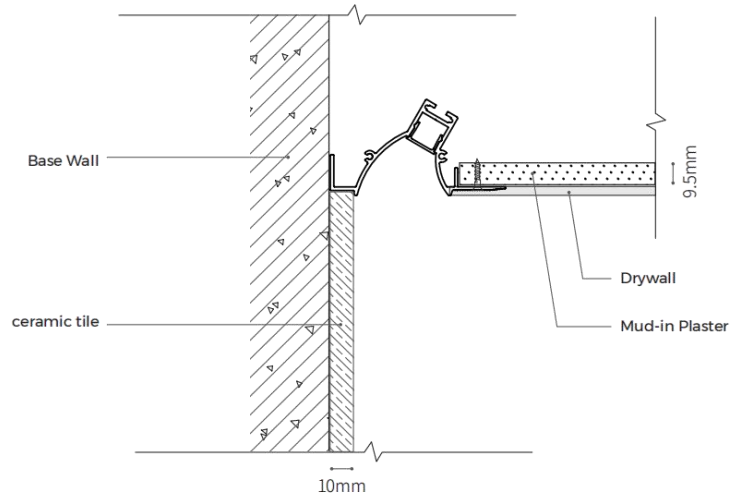

### Features

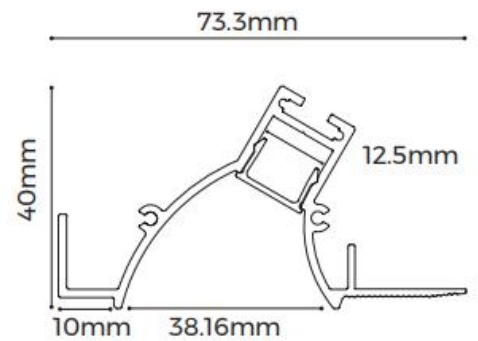

- Rimless recessed design, integrated into architecture.
- AL6063-T5 aluminum profile with high-quality surface treatment.
- Close-fitting end cap design without screw, make installation more convenient.



## Standard Configuration

Picture	Item	Parameter
	Profile	Profile weight : 1.75kg/2.5m Size : L2500*W73.3*H40mm Material : AL6063-T5 Surface processing : Spraying RAL9003
	Cover	Type: Frosted diffuse Material: PC Light transmittance : 60% Size : L2500*W13.5*H8.5mm (shrink) 0.8mm/m when the temperature rises (drops) 10°C.
	End caps	Size : L43.3*W40*H1.5mm Material : AL6063-T5

## Optional Accessories

Picture	Item	Parameter
	Flexible strip D6280-24V-8mm	Material : FPC , CCT : 2700/3000/4000/6000K ; Ra > 90; Voltage:24V ; Power : 15W/m ; Lumen : 1650Lm/m ; PCB width : 8mm ; Minimum cut : 7LED/25mm ;
	Screw	Size : M3.5*40mm Material : Carbon steel

## Optical Parameter

(D6280-24V-8mm light source, frosted diffuser)

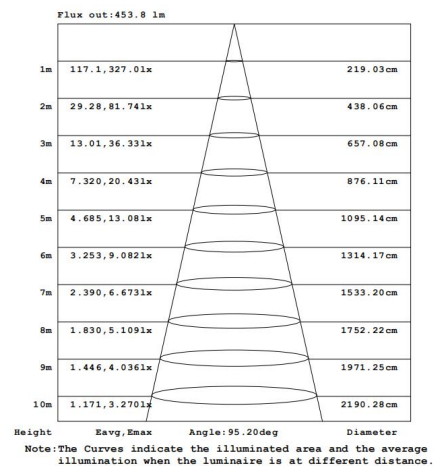
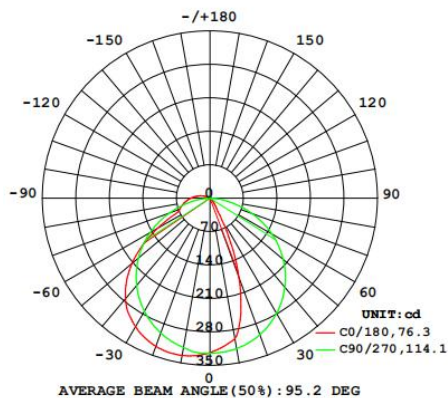

## Package

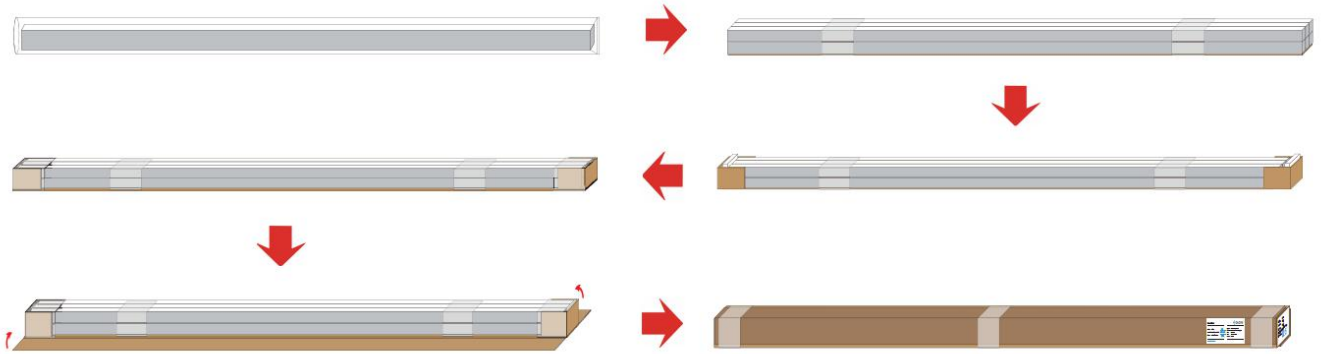

Item	Type	Size(mm)	NW(kg)	GW(kg)	Content
Profile and cover	Packing box	2600*210*150mm	21.4	23.6	12pcs/box

