

# Specification

Linear lighting system

LE6935(F)



## LE6935(F)



### Features



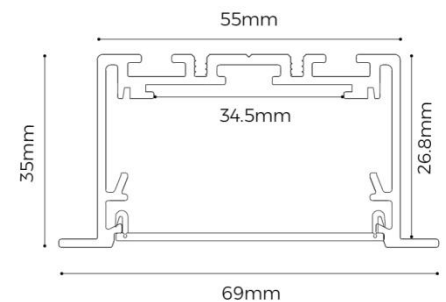

- Metal end cap design, Colorless difference with profiles
- Designed in anti-leaky block piece, perfect details
- Super free splicing combination: 180 ° direct connection, L type, T type, X type
- Recessed installation with two optional accessories of N-shaped buckle and butterfly clip
- Free to collocation ordinary PC diffuser, flexible diffuser, anti-glare flexible diffuser, black diffuser, aluminum diffuser
- AL6063-T5 aluminum profiles with high quality surface treatment and three optional colors of black, white and silver

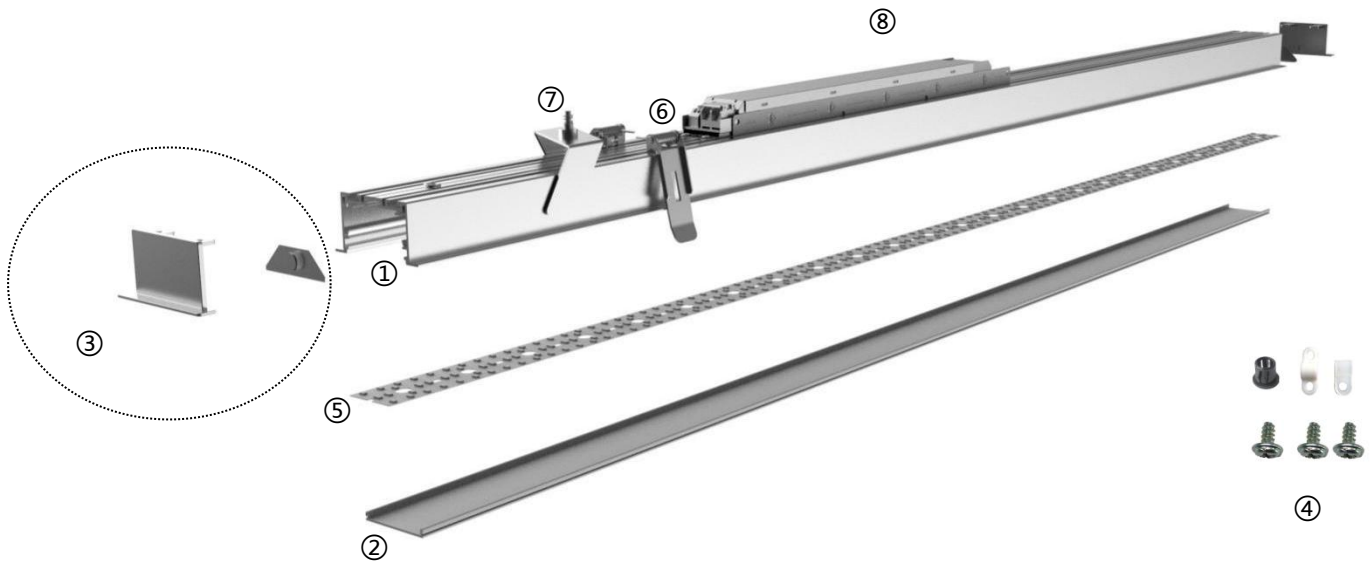

## Details









## Standard Configuration

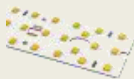

Picture	Item	Parameter
	Profile	Profile weight : 2.34kg/2.5m Size : L2500*W69*H35mm Material : AL6063-T5 Surface processing : Anodizing
	Cover	Type: Frosted diffuser Material : PC Light transmittance : 75% Size : L2500*W48.8*H5.6mm PC Feature : The diffuser will extend (shrink) 0.8mm/m when the temperature raises (drops) 10°C.
	③ End cap	Model : EC-LE6935(F)FSS Size : L69*W35*H22mm
	④ Cable clip	Model : BG-03



## Optional Accessories









Picture	Item	Parameter
	⑤Flexible strip D8280-24V-34mm	Material : FPC,CCT:1900/2300/2700/3000/3500/4000/5000/6000K ; CRI > 80/>95 ;Voltage :24V ;Power : 25W/m ;Lumen :3250Lm/m ; Width : 34mm ; Minimum cutting unit : 28LEDs/50mm ;
	⑤Flexible strip D8560SWW-24V-34mm	Material : FPC , CCT : 2700-6000K ; CRI > 80/>95 ; Voltage : 24V ; Power : 25W/m ; Lumen : 2740Lm/m ; Width : 34mm ; Minimum cutting unit : 28LEDs/50mm ; tunable white
	⑤Rigid modular DY8280-24V-36mm	Material : FR4,CCT:1900/2300/2700/3000/3500/4000/5000/6000K ; CRI > 80/>95 ;Voltage :24V ;Power : 25W/m ;Lumen :3250Lm/m ; Width : 36mm ; Minimum cutting unit : 28LEDs/50mm ;
	⑤Rigid modular DY8560SWW-24V-36mm	Material : FR4 , CCT : 2700-6000K ; CRI > 80/>95 ; Voltage : 24V ; Power : 25W/m ; Lumen : 2740Lm/m ; Width : 36mm ; Minimum cutting unit : 28LEDs/50mm ; tunable white
	⑥Recessed buckle (Butterfly clips)	Model : RB-02 Size : L68.5*W35*H31.6mm
	⑦Recessed buckle (N-shaped)	Model : RN-05 Size : L99.8*W59*H39.5mm
	⑧Power supply	Model : BSD-V24-065S Size : L346*W30*H23.5mm
	Reflective paper	Model : BG-14 Size : L15000*W19*H0.188mm

## Cover type

Picture	Item	Parameter
	②cover	Type: Diffuse flexible mask Material: PC + silica gel Transparency: 70% Size: L50000*W48.8*H5.6mm
	②cover	Type: Aluminum mask Material: Aluminum alloy Size: L2500*W48.8*H5.6mm
	②cover	Type: Night mask Material: PC Transparency: 15 % Size: L2500*W48.8*H5.6mm



## Corner fittings

EX-17	EX-E6 (7-type 120°)	EX-E7 (7-type 60°)	EX-E8 (L-type 120°)
			
EX-E9 (Y-type 120°)	EX-E10 (L-type 60°)	EX-E11 (X-type 60°+120°)	EX-E12 (T-type 60°+120°)
			

## Optical Parameter

D8280-24V-34mm light source, frosted diffuser

LUMINOUS INTENSITY DISTRIBUTION DIAGRAM

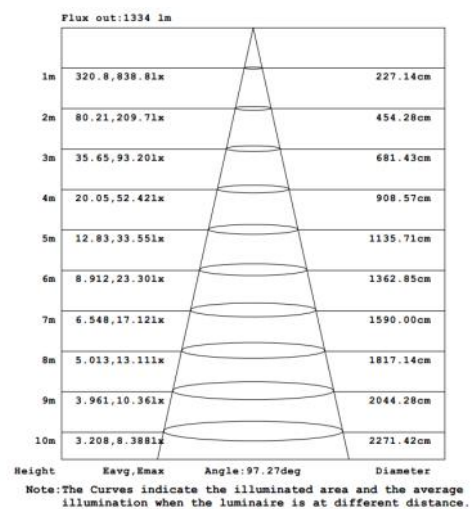
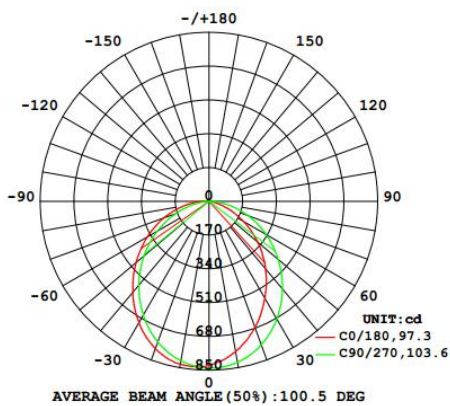

## Package

### Mode 1 :

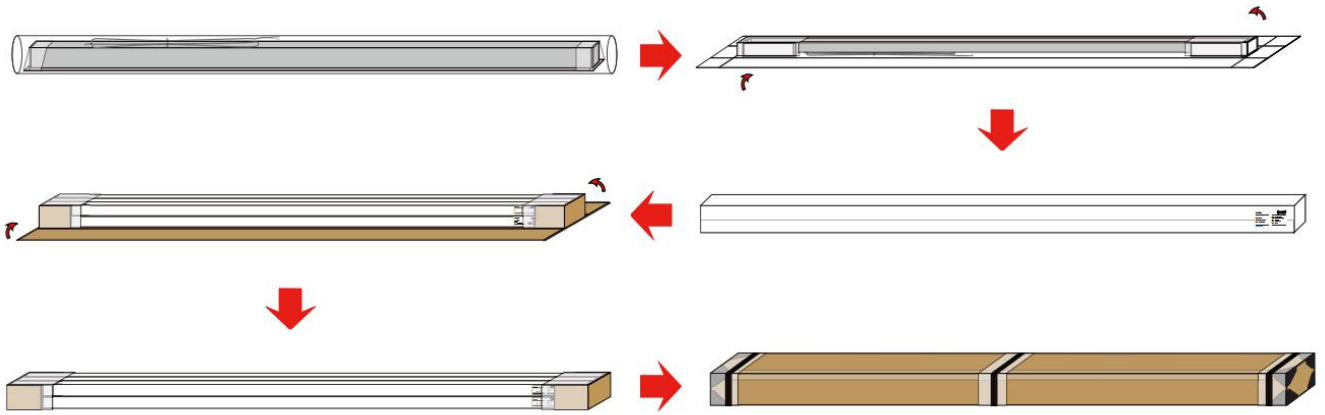

### Mode 2 :

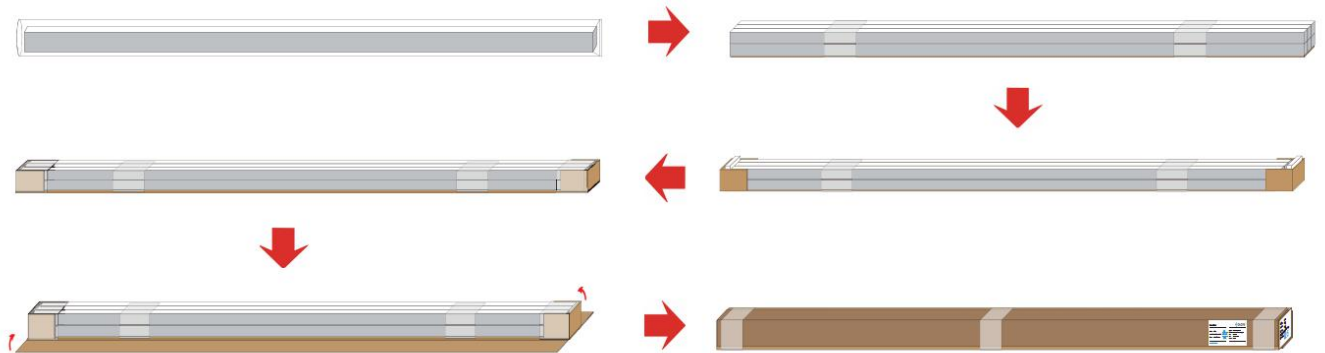

Components	Packaging material	Size(mm)	NW(kg)	GW(kg)	Content
Single piece	Hat box	2560*113*61mm	2.52	3.02	1pcs/box
Whole bundle	Hat box	2580*256*207mm	15.12	18.12	6pcs/box
Whole box packaging	Paper box	2580*211*170mm	20.16	23.16	8pcs/box

