

# Specification

Linear lighting system

LE5535



## LE5535

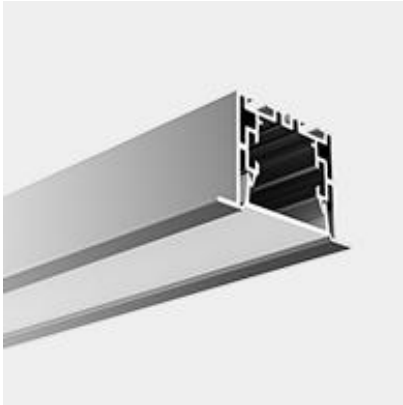

### Features



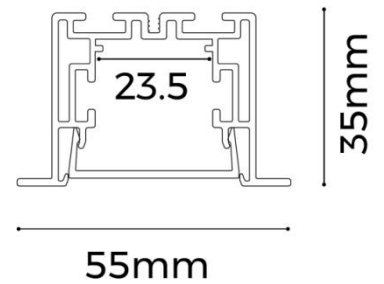

- Creative magnetic end cap, connect in seconds
- Designed in anti-leaky block piece , perfect details
- PC diffuser imported form Germany , producing homogeneous & soft lighting
- Provide standard extenders , customizable interconnected corners
- Recessed installation with two optional accessories of N-shaped buckle and butterfly clip
- Winner of IF Design Awards 2016

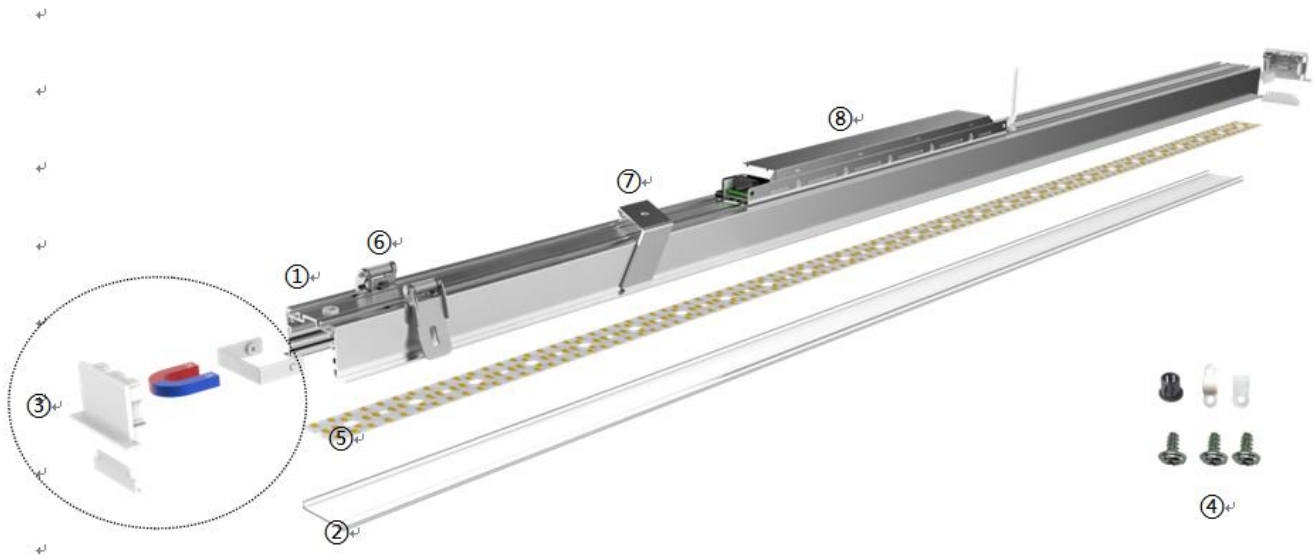

## Details







## Standard Configuration



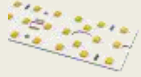



Picture	Item	Parameter
	① Profile	Profile weight : 1.1kg/2.5m Size : L2500*W55*H35mm Material : AL6063-T5 Surface processing : Anodizing
	② Cover	Type: Frosted diffuser Material : PC Light transmittance : 86% Size : L2500*W34.2*H10.2mm PC Feature : The diffuser will extend (shrink) 0.8mm/m when the temperature raises (drops) 10°C.
	③ End cap	Model : EC-LE5535FSS Size : L55*W35*H18mm
	④ Cable clip	Model : BG-02



## Optional Accessories

Picture	Item	Parameter
	⑤Flexible strip D8280-24V-20mm	Material : FPC,CCT:1900/2300/2700/3000/3500/4000/5000/6000K ; CRI > 80/>95 ; Voltage : 24V ; Power : 20W/m ; Lumen : 2700Lm/m ; Width : 20mm ; Minimum cutting unit : 14LEDs/50mm ;
	⑤Rigid modular DY8280-24V-23mm	Material : FR4,CCT:1900/2300/2700/3000/3500/4000/5000/6000K ; CRI > 80/>95 ; Voltage : 24V ; Power : 20W/m ; Lumen : 2700Lm/m ; Width : 20mm ; Minimum cutting unit : 14LEDs/50mm ;
	⑥Recessed buckle (Butterfly clips)	Model : RB-02 Size : L68.5*W35*H31.6mm
	⑦Recessed buckle (N-shaped)	Model : RN-04 Size : L107.3*W45*H39.5mm
	⑧Power supply	Model : BSD-V24-065S Size : L346*W29.5*H23.5mm
	Reflective paper	Model : BG-13 Size : L15000*W16*H0.075mm

## Corner fittings

EX-E6 (7-type 120°)	EX-E7 (7-type 60°)	EX-E8 (L-type 120°)	EX-E8 (L-type 120°)
			
EX-E10 (L-type 60°)	EX-E11 (X-type 60°+120°)	EX-E12 (T-type 60°+120°)	
			



## Corners

L-type corner (L90- LE5535)



Al6063-T5&PC  
3.1W  
L107\*W107\*H35m

L-type inner corner(L90N- LE5535)



Al6063-T5&PC  
4W  
L100\*W100\*H55

L-type exterior corner(L90W- LE5535)

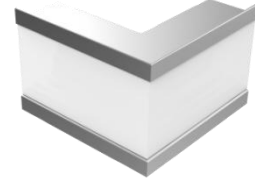

Al6063-T5&PC  
4W  
L100\*W100\*H55m

T-type corner(T90- LE5535)



Al6063-T5&PC  
4W  
L150\*W107\*H35m

X-type corner(X90- LE5535)

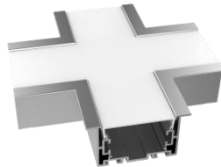

Al6063-T5&PC  
5W  
L150\*W150\*H35m

180° extender



SPCC  
silver  
L80\*W10\*H2mm

\* The corners can be provided with or without light source

## Optical Parameter

D8280-24V-20mm light source, frosted diffuser

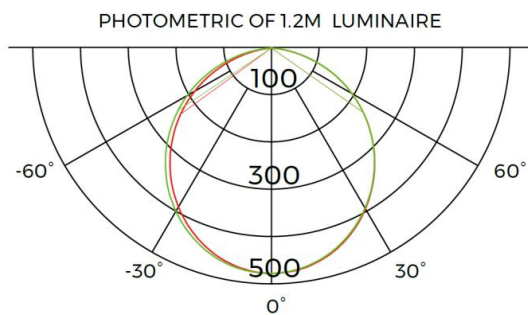

1m	147.8,477.8lx	279.05cm
2m	36.95,119.5lx	558.10cm
3m	16.42,53.09lx	837.14cm
5m	5.913,19.11lx	1395.24cm
7m	3.017,9.7521lx	1953.34cm
Height	Eavg,Emax	Angle:108.74deg Diameter



## Package

Mode 1 :

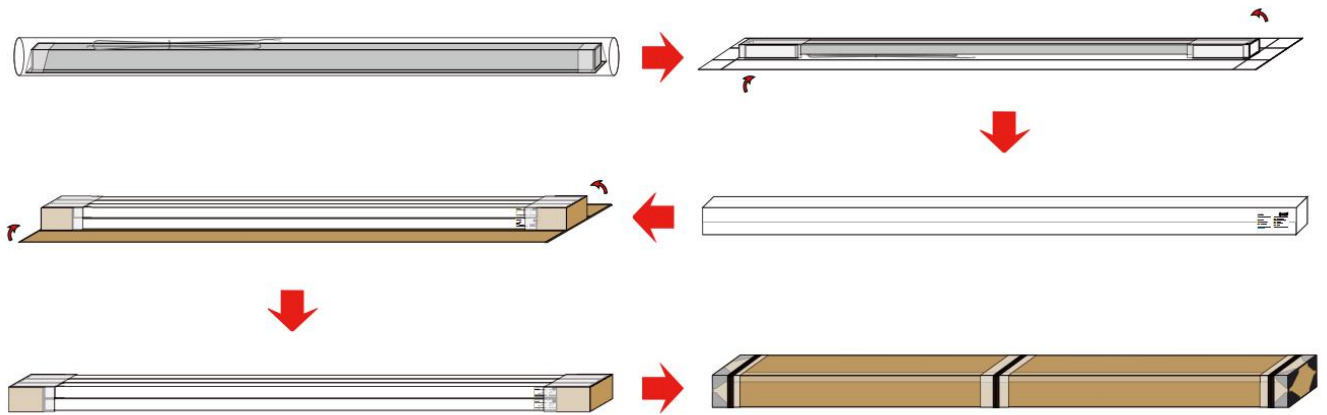

Mode 2 :

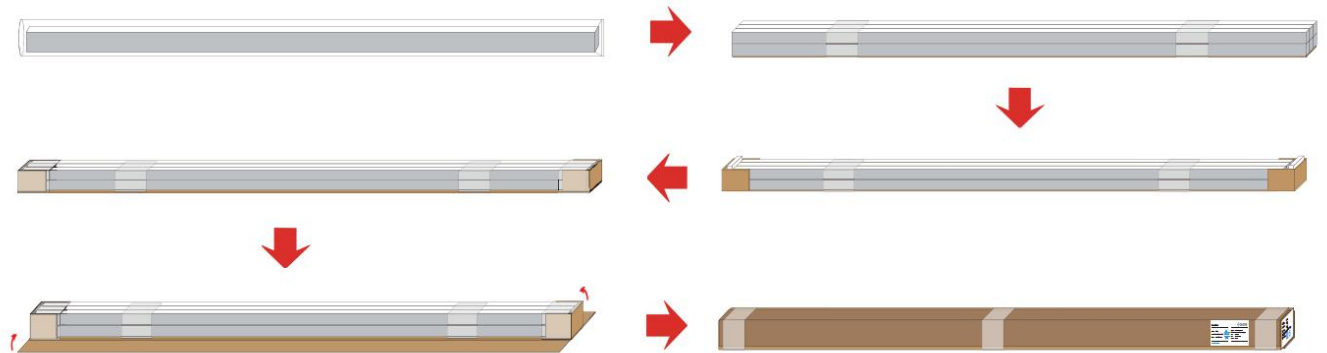

Components	Packaging material	Size(mm)	NW(kg)	GW(kg)	Content
Single piece	Hat box	2560*85*61mm	4	4.5	1pcs/box
Whole bundle	Hat box	2580*285*145mm	24	27	6pcs/box
Whole box packaging	Paper box	2580*153*168mm	32	35	8pcs/box

