

# Specification

Basic series

BS5470



## BS5470



### Features



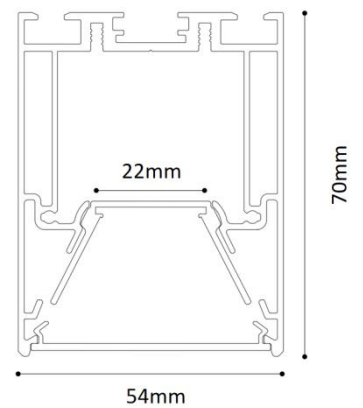

- Innovative buckle plug, no light leakage
- Carrier tight fit design carrier buckle extremely convenient for installation and maintenance
- Designed in anti-leaky block piece, perfect details
- PC diffuser imported from Germany, producing homogeneous & soft lighting
- Free to collocation ordinary PC diffuser, flexible diffuser, anti-glare flexible diffuser, black diffuser, aluminum diffuser
- Provide standard extenders, customizable interconnected corners
- Built-in linear power supply, invisible and beautiful
- Various installation ways: pendant, recessed, surface

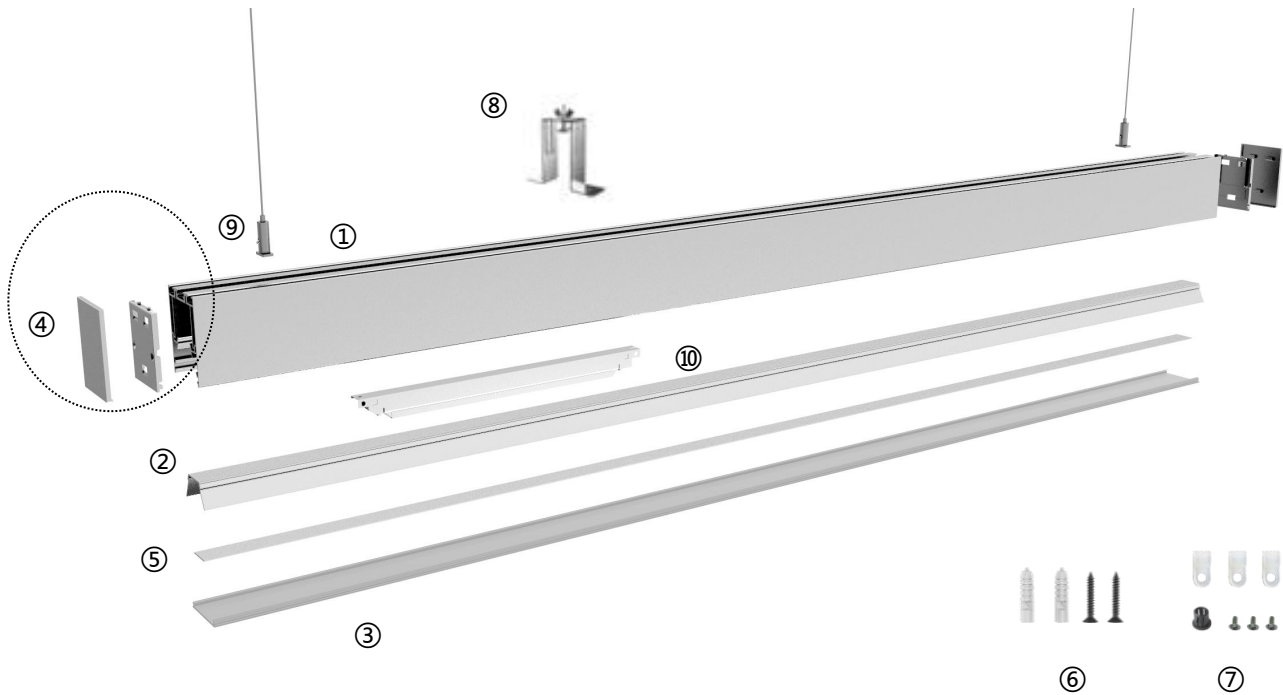

## Details













## Standard Configuration

Picture	Item	Parameter
	①Profile /②Carrier	Profile weight : 3.4kg/2.5m Size : L2500*W54*H70mm Material : AL6063-T5 Surface processing : Anodizing
	③Cover	Type: Frosted diffuser Material: PC; Light transmittance: 75% Size : L2500*W48.8*H5.9mm PC Feature: The diffuser will extend (shrink) 0.8mm/m when the temperature raises (drops) 10°C.
	④End cap	Model: EC-BS5470FSS Size : L54*W70*H10.5mm
	⑥Install screw	Model: CL-01 Size : M3.5*40mm
	⑦Cable clip	Model: BG-02





## Optional Accessories

Picture	Item	Parameter
	⑤Flexible strip DL8280-24V-18mm	Material: FPC,CCT:2700/3000/3500/4000/5000/6500K; CRI > 80/>90; Voltage: 24V; Power: 25W/m; Lumen: 3400Lm/m; Width: 18mm; Minimum cutting unit: 14LEDs/50mm;
	⑨Pendant cable with junction box	Model: PY-DXXX Junction box L80*W80*H30mm
	⑨Pendant cable without junction box	Model: PN-DXX Steel cable D1.5*2000/4000mm
	⑧Recessed buckle	Model: RE-03 Size: L110*W25*H82mm
	Surface mounted buckle	Model: CL-06 Size: L90.5*W54*H5.9mm
	Pendant rod	Model: PG-IA2 Size: 1-2m
	Reflective paper	Model: BG-13 Size: L15000*W19*H0.188mm
	Integrated track cabling accessories	Dimming: CM-03; CM-06 No dimming: CM-04; CM-05
	Power supply	Model: BN-V24-060P-V1 Size: L261*W30*H17mm
	Whole lamp splice	Model: EX-39-S Size: L80*W51*H6mm

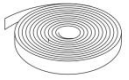

## Cover type

Picture	Item	Parameter
	②cover	Type: Diffuse flexible mask Material: PC + silica gel; Transparency: 70 % Size: L50000*W48.8*H5.6mm
	②cover	Type: Aluminum mask Material: Aluminum alloy Size: L2500*W48.8*H5.6mm
	②cover	Type: Night mask Material: PC; Transparency: 15 % Size: L2500*W48.8*H5.6mm

## Corners

L-type corner (L90- BS5470)

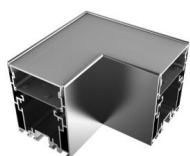

Al6063-T5  
L150\*W150\*H70mm

L-type corner (L90- BS5470)



Al6063-T5  
L150\*W150\*H54mm

L-type corner (L90- BS5470)



Al6063-T5  
L150\*W150\*H54mm

T-type corner(T90-BS5470)

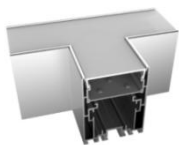

Al6063-T5  
L300\*W177\*H70mm

X-type corner(X90- BS5470)



Al6063-T5  
L300\*W300\*H70mm

\* The corners can be provided with or without light source.

## Optical Parameter

DL8280-24V-18mm light source, frosted diffuser

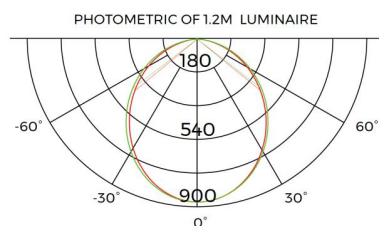

Height	Eavg,Emax	Angle:101.12deg	Diameter
1m	312.8,877.3lx		243.14cm
2m	78.20,219.3lx		486.29cm
3m	34.75,97.48lx		729.43cm
5m	12.51,35.09lx		1215.71cm
7m	6.384,17.90lx		1966.01cm



## Package

COLORS Individual :

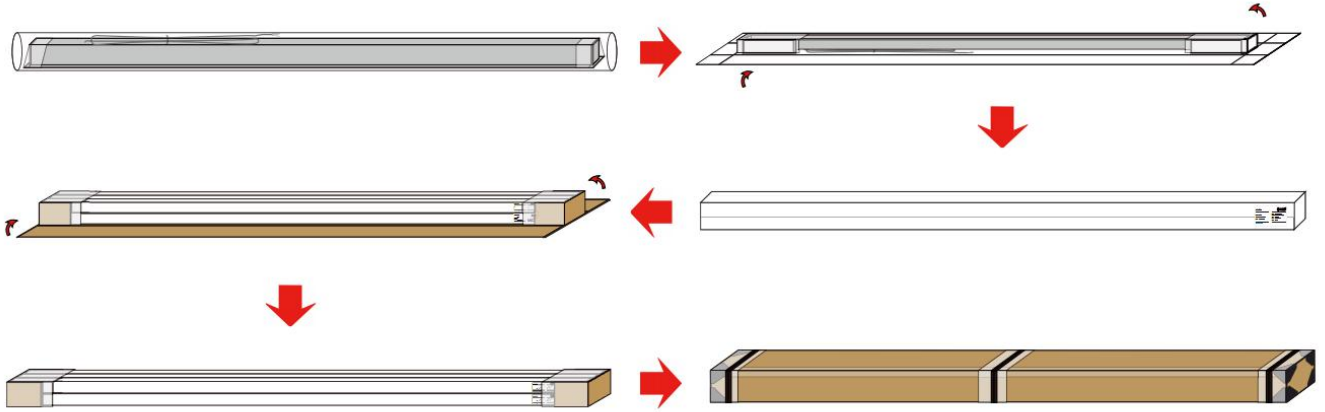

COLORS Whole :

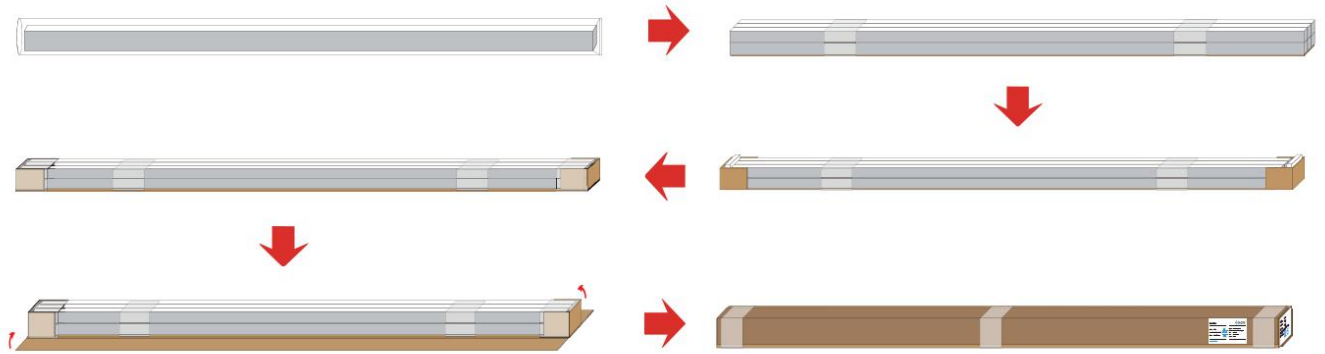

Components	Packaging material	Size(mm)	NW(kg)	GW(kg)	Content
Single piece	Hat box	2560*99*65mm	4.62	5.12	1pcs/box
COLORS Individual	Hat box	2580*228*219mm	27.72	30.72	6pcs/box
COLORS Whole	Paper box	2580*192*168mm	27.72	30.72	6pcs/box

