

Specification

Basic series

BH7977



BH7977

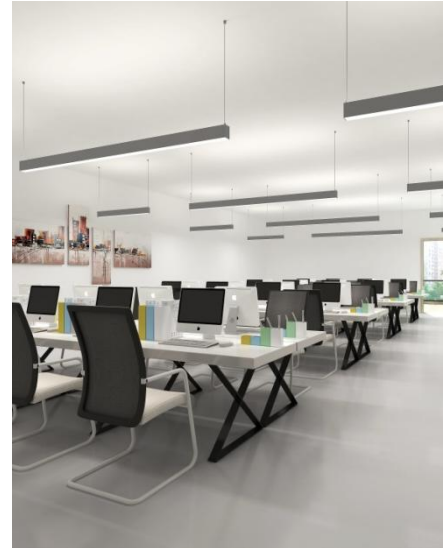

Features



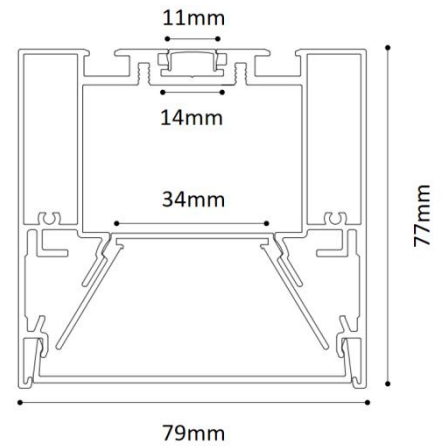

- Innovative buckle plug, no light leakage
- Carrier tight fit design carrier buckle extremely convenient for installation and maintenance
- Designed in anti-leaky block piece, perfect details
- PC diffuser imported from Germany, producing homogeneous & soft lighting
- Provide standard extenders, customizable interconnected corners
- Built-in linear power supply, invisible and beautiful
- Various installation ways: pendant, recessed, surface

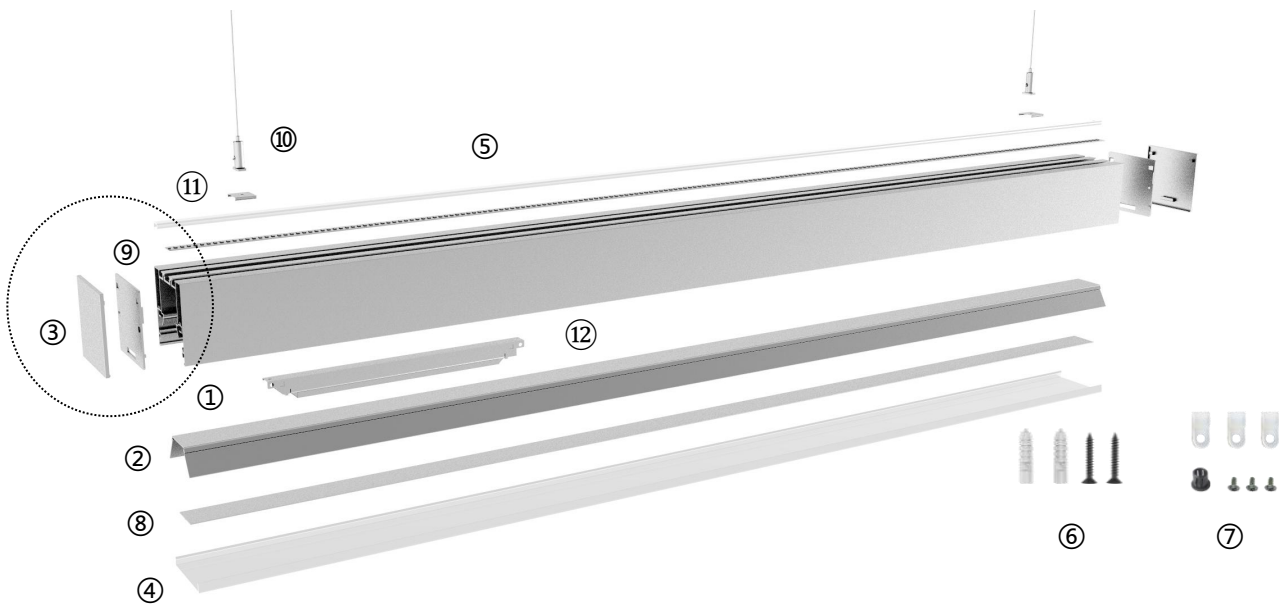

Details













Standard Configuration

Picture	Item	Parameter
	①Profile /②Carrier:	Profile weight : 4.02kg/2.5m Size : L2500*W54*H70mm Material : AL6063-T5 Surface processing : Anodizing
	④/⑤Cover	Type: Frosted diffuser Material: PC Light transmittance: 75% Size : L2500*W62*H26.4mm PC Feature: The diffuser will extend (shrink) 0.8mm/m when the temperature raises (drops) 10°C.
	③End cap	Model: EC-BS7977FSS Size : L79*W77*H10mm
	⑥Install screw	Model: CL-01 Size : M3.5*40mm
	⑦Cable clip	Model: BG-21



Optional Accessories

Picture	Item	Parameter
	⑧Flexible strip DL8280-24V-30mm	Material: FPC,CCT:2700/3000/3500/4000/5000/6500K; CRI > 80/>90; Voltage: 24V; Power: 30W/m; Lumen: 4100Lm/m; Width: 30mm; Minimum cutting unit: 14LEDs/50mm;
	⑨Flexible strip DL8160-24V-8mm	Material: FPC,CCT:2700/3000/3500/4000/5000/6500K; CRI > 80/>90; Voltage: 24V; Power: 15W/m; Lumen: 2015Lm/m; Width: 8mm; Minimum cutting unit: 8LEDs/50mm;
	⑩Pendant cable with junction box	Model: PY-LXXX Junction box L80*W80*H30mm
	⑩Pendant cable without junction box	Model: PN-LXX Steel cable D1.5*2000/4000mm
	⑪clip	Model: CP-35
	Pendant rod	Model: PG-IA2 Size: 1-2m
	Reflective paper	Model: BG-24 Size: L25000*W26.3*H0.2mm
	Integrated track cabling accessories	Dimming: CM-03; CM-06 No dimming: CM-04; CM-05
	⑫Power supply	Model: BN-V24-060P-V1 Size: L329*W30*H17mm
	Whole lamp splice	Model: EX-24 Size: L80*W51*H6mm



Corners

L-type corner (L90- BH7977)

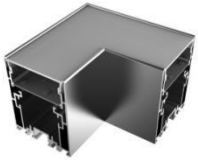

Al6063-T5
L150*W150*H77mm

T-type corner(T90- BH7977)



Al6063-T5
L300*W177*H77mm

X-type corner(X90- BH7977)



Al6063-T5
L300*W300*H77mm

* The corner without light source.

Optical Parameter

DL8280-24V-30mm/DL8160-24V-8mm light source, frosted diffuser

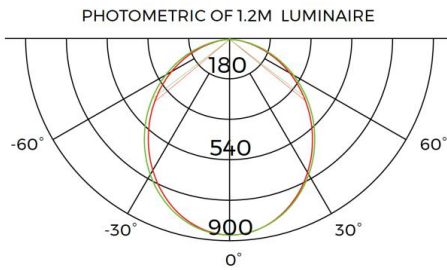

1m	312.8,877.3lx	243.14cm
2m	78.20,219.3lx	486.29cm
3m	34.75,97.48lx	729.43cm
5m	12.51,35.09lx	1215.71cm
7m	6.384,17.90lx	1966.01cm
Height	Eavg,Emax	Angle:101.12deg Diameter



Package

Mode 1 :

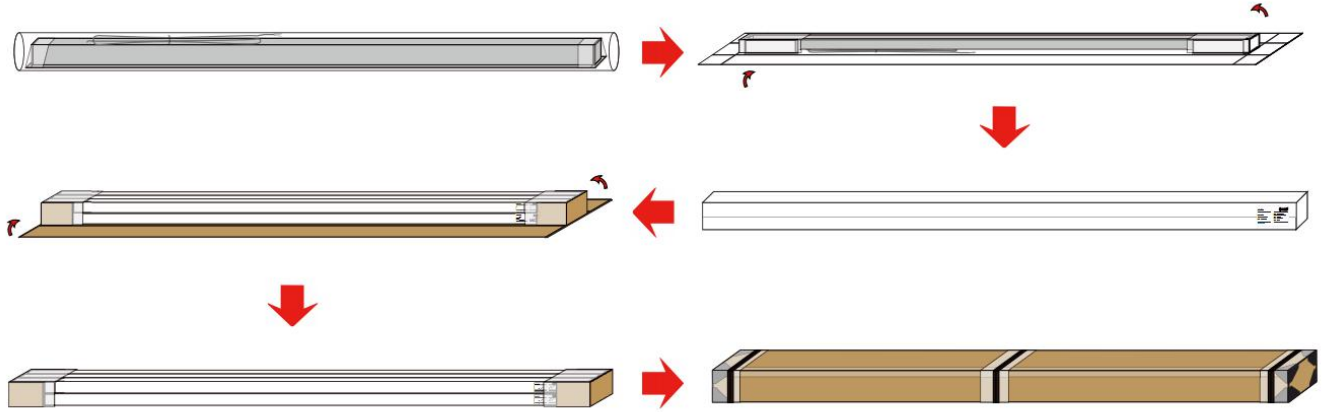

Mode 2 :

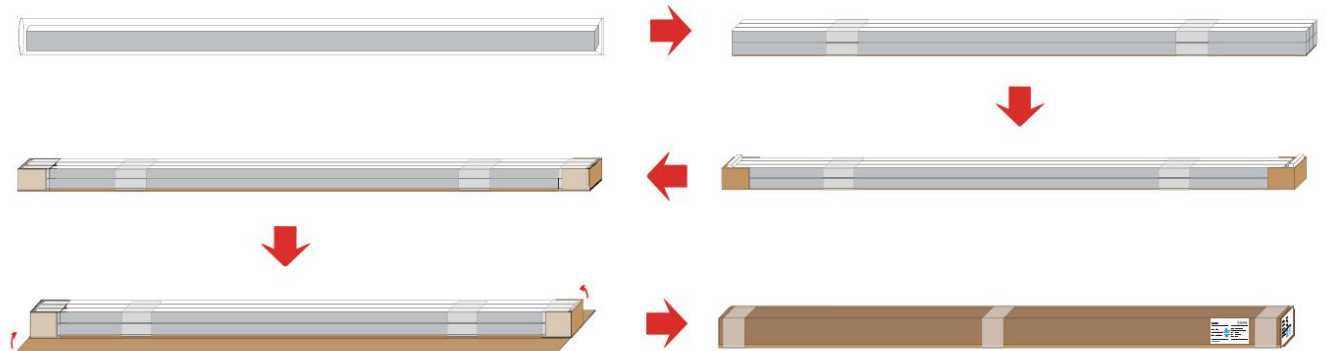

Components	Packaging material	Size(mm)	NW(kg)	GW(kg)	Content
Single piece	Hat box	2560*106*90mm	4.62	5.37	1pcs/box
Whole bundle	Hat box	2580*242*204mm	18.48	21.48	4pcs/box
Whole box packaging	Paper box	2580*188*182mm	18.48	21.48	4pcs/box

